

POLYMER CAPACITORS VS. MLCCS

WHITE PAPER

VERSION 1.0

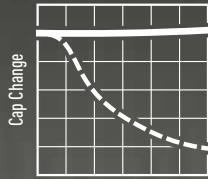

DC Bias

NO DC BIAS

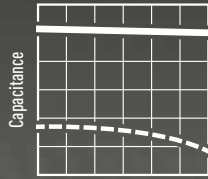

Time

NO DERATING



**NO SOLDER
JOINT/CRACKING**



**LONGER PREDICTABLE
LIFETIMES**

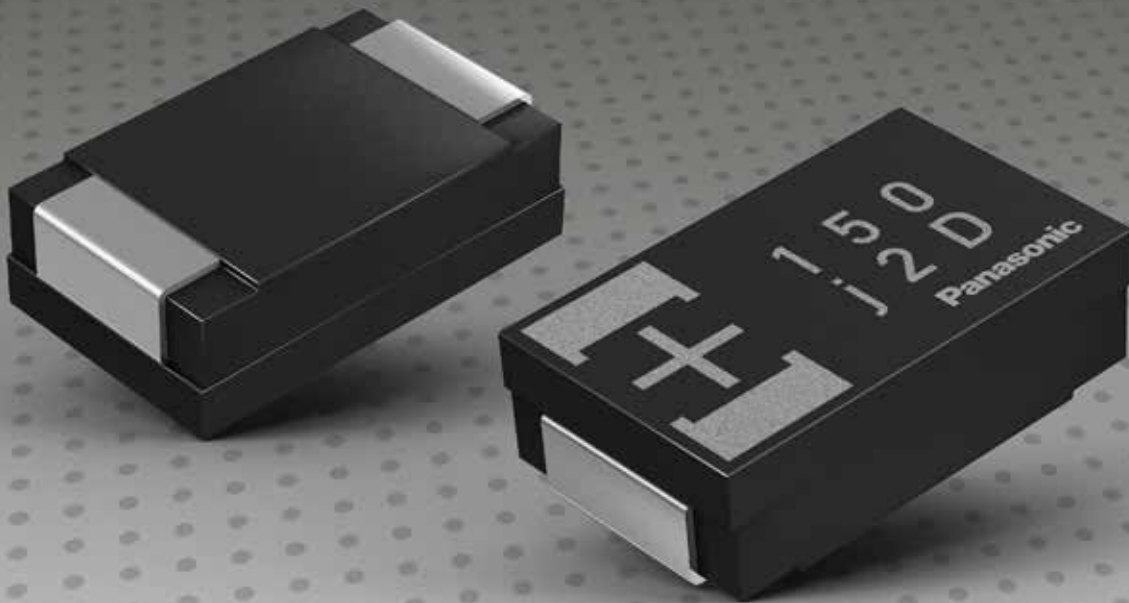

**POLYMER CAPACITORS –
AN OPTIMAL REPLACEMENT FOR MLCCS**

TABLE OF CONTENTS

INTRODUCTION3

POLYMER CAPACITORS AS ALTERNATIVE TO MLCCS5

USER CASE10

CIRCUIT EXAMPLE.....11

INTRODUCTION

Most often capacitor selection to the uninformed seems like a simple choice but the demands, challenges and expectations of modern electronics prove otherwise. As more electronic systems continue to be integrated into our automobiles, the need for capacitor technologies that deliver high reliability, long life, stable performance, low ESR and low cost continue to grow. Polymer capacitors have met these needs in the enterprise, commercial, consumer, medical, and aerospace segments for more than 15 years. But polymer technology has been challenged when it comes to meeting the AEC Q200 requirements. Today, these challenges are being overcome as polymer capacitor technology makes its entrance into the automotive segment. These changes are a direct answer to the new requirements capacitors have to fulfill. In order to exemplify let's take a look at e.g. DCDC converters and how their requirements have changed: While DCDC converters have been required to have high efficiency, low noise and miniaturization, one of the recent additional requirements is faster transient response characteristics to the load change. This is because ICs, etc. have been developing into the directions of higher speed, larger current and lower voltage operation. These achievements of the semiconductor industry have set trends in current and future electronic devices: Efficient power consumption, increasing load current, miniaturization and higher switching frequencies. IC operation of the high-speed and large current comes to increase variations in current load, and the low voltage operation comes to require very accurate stability in voltage. All of them require faster transient response for the converter to support the ICs. These trends entail capacitors that can cope with higher current loads while at the same time the available volume is decreasing. Electric engineers find themselves more and more confronted with the task to balance between high performance & power density vs. long term endurance, high reliability & safety.

The selection of a suitable output/input capacitor plays an important part in the design of switching voltage converters. "Some 99 percent of so-called 'design' problems associated with linear and switching regulators can be traced directly to the improper use of capacitors", states

the National Semiconductor IC Power Handbook.

"Polymer capacitors offer higher capacitance values than MLCC capacitors"

The importance of the output capacitor in switching DCDC converters is related to the fact that it is (together with the main inductor) the reservoir of electric energy flowing to the output and it smoothes the output voltage. Some important considerations for input capacitors used in DCDC converters are the power dissipation and ripple performance. To maintain the voltage and to make sure the rail voltage is stable to the converter, an input capacitor is required.

Various capacitor types can be used in the input and outputs of DCDC converters. Table 1 shows various kinds of capacitor including electrolytic capacitors, OSCON, SP-Cap, POS-Cap, film capacitor, and multilayer ceramic capacitors (MLCC), and ranks their performance according to each characteristic. The application typically dictates the best choice of capacitor type (MLCC, aluminum electrolytic, polymer, or tantalum) to use in the design. But before we get to that, generally speaking, following differentiation can be made: while electrolytic capacitors provide the largest ESR these capacitors suffer significant degradation in capacitance and leakage current at higher temperatures and frequencies. Ceramic capacitors have a very low ESR and ESL that makes them great for transient performance but they have limitations on capacitance derating. Though ceramic capacitor can operate at very high ripple currents, they suffer the non-graceful aging failure and require lower operating electric fields. Polymer electrolytic capacitors are mainly used in power supplies of integrated electronic circuits as buffer, bypass and decoupling capacitors, especially in devices with flat or compact design. Thus they compete with MLCC capacitors, but offer higher capacitance values than MLCC, and they display no microphonic effect (such as class 2 and 3 ceramic capacitors).

Table 1

	Capacity	Temp Characteristic	DC bias Characteristic	Voltage Range	Size	ESR	Ripple
Electrolyte	✓✓	✓	✓	✓✓	✗	○	○
OSCON	✓✓	✓✓	✓✓	✓	✓	✓✓	✓✓
SP-Cap	○	✓	✓✓	○	○	✓✓	✓✓
POS-Cap	✓	✓✓	✓✓	○	✓	✓✓	✓✓
MLCC	✗	○	✗	✓✓	✓✓	✓✓	✓✓

✓✓ very good ✓ good ○ medium ✗ bad

MLCCs capacitors are by far the most widely used capacitor type in DCDC converter input and output filters, due to their earlier mentioned low ESR, low ESL and low costs. So does this mean the equation is: no capacitor next MLCC when it comes to DCDC converters? It is not that easy as it might seem, especially since there are still some downsides to be considered when it comes to using these capacitor in DCDC converters:

- > Small capacitance per volume, especially for class 1 dielectric materials (NO/COG)
- > Large body sizes prone to cracking with PCB flex
- > DC bias instability
- > Piezo-Effect (singing)

“The polymer capacitor are featured by large capacitance and excellent bias characteristics”

This is where polymer capacitors come into play. Panasonic is a leading manufacturer of Solid Polymer Aluminum Capacitors: SP-Caps and OS-CON, Tantalum Polymer Capacitor – POS-CAP as well as Polymer Hybrid Aluminum Electrolytic Capacitor technologies and has the longest design-in expertise and experience on the market. Conductive polymer aluminum solid capacitors, abbreviated to “polymer capacitors” in the following, have been extending in their application. The polymer capacitor (as well as conventional aluminum electrolytic capacitors) are featured by large capacitance and excellent bias characteristics which multilayer ceramic capacitors can never compete with. In addition to these advantages polymer capacitors have extremely low ESR characteristics. Regarding ESL, which is determined by inside structure and terminal configuration of the capacitors, by making structural improvements, the polymer capacitors have low ESL. Also concerning the dry-out of electrolyte in service life and the changes of characteristics at a range of low temperatures the polymer capacitors have realized very high reliability and superior low temperature characteristics by using solid polymer materials as an electrolyte.

POLYMER CAPACITORS AS ALTERNATIVE TO MLCCS

Especially the SP-CAPs and POS-CAPs with their small size factor and cubical form are the go to products when it comes to the replacement of MLCCs. By looking closer at the characteristics of these different technologies once can see some major differences between them.

Stable vs. Frequency

Stable Capacitance: Figure 1 below shows the change in capacitance over a wide frequency range for different technologies. It clearly shows that polymer capacitors exhibit very similar performance to multi-layer ceramic capacitors.

“Capacitance for polymer capacitors does not vary significantly”

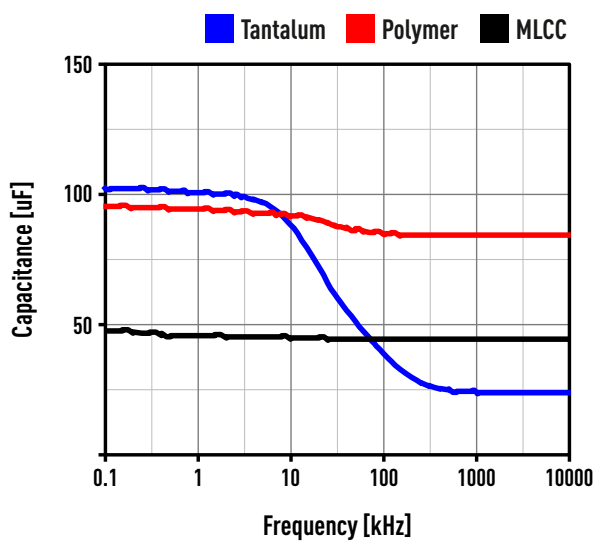

Figure 1

Capacitance Density / Stability vs. DC Bias

Looking at the results in figure 1 may rise the question why should somebody switch to polymer technology. The answer for this questions is: MLCCs cannot achieve the same high capacitance as polymer for the same given footprint and volume. Secondly, the MLCC exhibits strong capacitance dependence on DC bias due to ferroelectric dielectric materials used for MLCCs. High-capacity, multilayer ceramic capacitors have a property often not well understood by electronic designers i.e. stability and reliability require extensive whetting. The capacitance of these devices varies with applied DC voltage which can lead to a capacity drop of more than 70% compared to the given specs on the data sheet. For polymer capacitors the capacitance does not vary significantly when the application voltage changes (compare figure 2).

This advantages allow a significant lower part count using SP-CAPs or POSCAPs instead of MLCCs, which not only safes space on the PCB but also is a cost factor by saving costs on parts and reducing the production steps. Especially pertinent given supply issues with MLCC, a phenomenon observed from early 2017 and expected to last well into 2019.

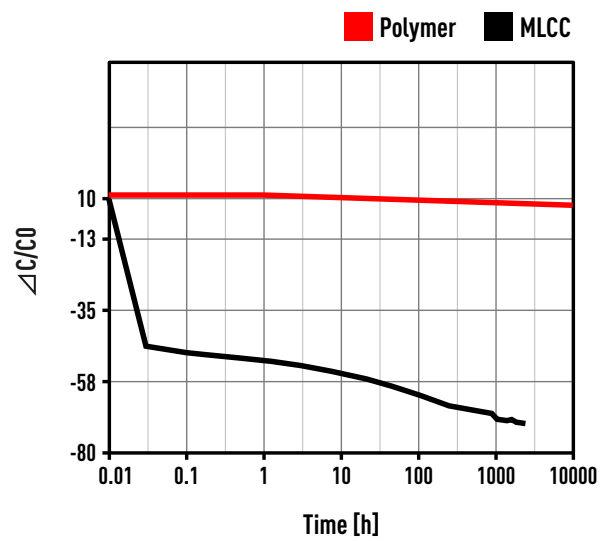

Figure 2

Stability vs. Temperature

Figure 3 shows typical temperature characteristics. The curve changes for MLCCs in various ways within the tolerance range of each product. For polymer capacitors the capacitance is growing in parallel to the temperature rise. The temperature characteristics of MLCCs differ according to the dielectric type but all of them suffer aging failure by exhibiting temperature dependency and require lower operating temperature. Ceramic capacitors are brittle and sensitive to thermal shock, so precautions need to be taken to avoid cracking during mounting, especially for high-capacitance large MLCCs. The typical temperature range for ceramic capacitors is -40°C to 85°C or 125°C, wherein their capacitance varies about from +5% to -40% having the sweet spot around the low temperature of 5 to 25°C. Polymer capacitors have great development potential to achieve higher ratings on density, field stress and temperature (yet currently limited to 125°C) due to their working mechanism and dielectric materials advancement, yet higher dielectric constant polymers enable a high energy density.

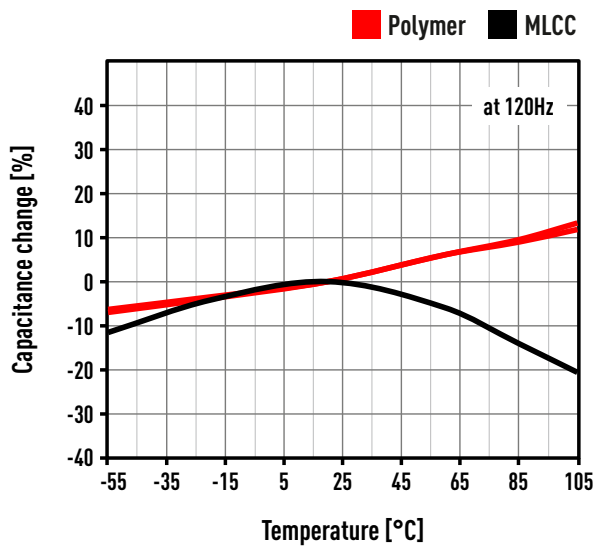

Figure 3

Piezoelectric Effects Ceramic Chip Capacitor

Most dielectrics of ceramic capacitors exhibit a characteristic identified as piezoelectric effects that can cause unexpected signals in certain circuits. In some cases, the piezoelectric effect may result in the appearance of electrical noise. When an electric potential or field is applied on the surface of an MLCC causes a deformation at a frequency range from 20Hz-20kHz, it could be audible to humans. This is then called the MLCC acoustic noise or singing noise (compare figure 4). A MLCC alone is in most cases not sufficient to generate problematic or disruptive Sound Pressure Level (SPL). But soldered on a PCB board the MLCC generates a spring mass system, which increases or dampens the oscillations depending on the frequencies.

“MLCCs suffer aging failure by exhibiting temperature dependency”

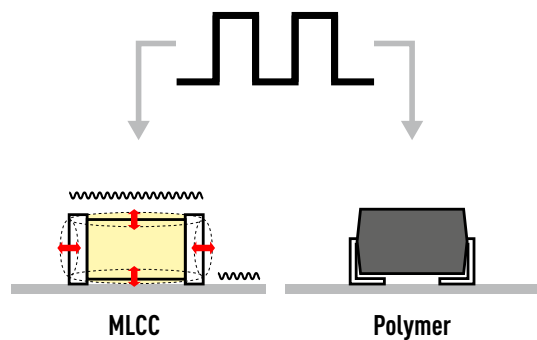

Figure 4

Robust

Cracks in ceramic surface mount technology (SMT) components limit assembly reliability and yields. These cracks manifest themselves as electrical defects: intermittent contact, variable resistance, loss of capacitance and excessive leakage currents. That is why MLCCs are exposed to different reliability tests including thermal shock, board flex (bending), and biased humidity tests, etc., depending on the targeted applications. MLCCs are exposed to more than ten reliability test including thermal shock, board flex (bending), and biased humidity tests, etc., depending on the targeted applications. Among the reliability tests, the board flex test evaluates the mechanical resistance to cracking when MLCCs are subjected to bending stress on the printed circuit board (PCB) that the MLCC is soldered on. The bending of PCB can occur frequently during/between manufacturing steps and during operation under temperature variations. Flex cracking is due to excessive circuit board flexure.

As for the causes of board flexure, there are various causes including problems during the manufacturing process, such as solder stress due to an inappropriate amount of solder, stress applied at the time of depaneling or screw fastening, or board flexure at the time of final assembly, in addition to drops, vibration, or thermal expansion during use. Ceramics are strong in compression but weak in tension. It is for this reason MLCC suppliers provide guidelines for buying out MLCC on PCB boards, often directing the MLCC caps not to be layed out at the edges of the board or to control the direction of MLCC chip along the length rather than the width when tension is expected at a certain point of the PCB. This limits and may require changes on the part of the design engineer before closing a PCB layout. Thus, when a soldered MLCC experiences excessive board flex, a crack is easily generated in the element (compare figure 5). A flex crack can cause an electrical conduction between opposing internal electrodes. It is also possible that an fail open can progress to a fail short with continue product usage. If a crack on a capacitor element progresses to a short circuit failure, it may cause problems such as heat generation, smoking, or ignition; therefore, it is indispensable to take measures against them, particularly in equipment where reliability is essential.

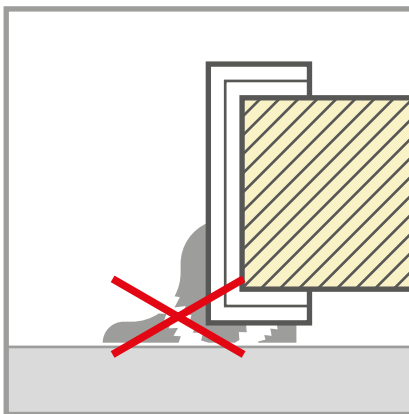

Figure 5

Safety

Most ceramic capacitors have a fairly high voltage rating. If the capacitor experiences a voltage between its terminals higher than its rated voltage, the dielectric may break down and electrons will flow between the thin metal layers inside of the capacitor, creating a short. Luckily, most ceramic capacitors are built with a hefty safety margin and do not experience any sort of catastrophic failure (such as exploding). However, the rule of thumb dictates that you should derate ceramic capacitors by 50%, which means that if you are expecting to have a maximum of 5V between the capacitor's leads, then you should use a capacitor rated for 10V or more.

In order to understand the lifetime properties of polymer vs. MLCCs you have to take the construction and properties of each one into account (Please also compare figure 6 on the next page). Polymer capacitors are coming as chip type or wound type products. Since solid polymer capacitors are not regarded as components which are likely to be replaced in a device, they are often made in SMT (Surface-Mount-Technology). This allows them to take up less space on the PCB at the expense of being harder to unsolder if replacements are necessary. However, adopting SMT technology overall for a PCB also allows automated mounting, reducing costs and minimal human interference.

The use of solid electrolyte is a major advantage over electrolytic capacitors. In a wet electrolytic capacitor overheating can cause the electrolyte to evaporate. As it evaporates, pressure builds up within the capacitor and it may burst or even explode. Solid polymer capacitors don't have such risks— the capacitor either shorts or starts acting like an open circuit towards the end of its lifetime. Generally speaking, the reliability of polymer capacitors is much better than the reliability of electrolytic capacitors and particularly MLCCs.

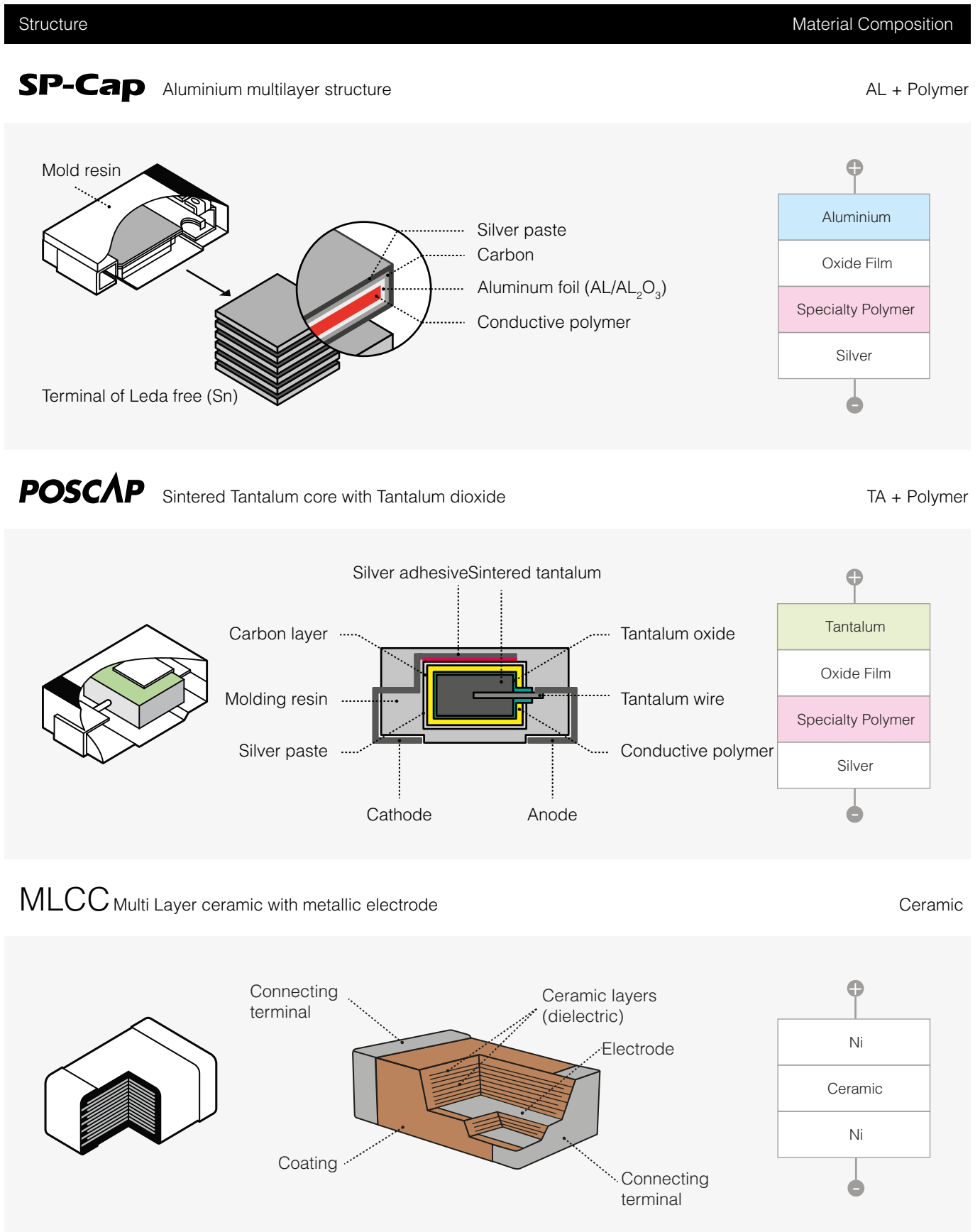

Figure 6

USER CASE

The comparison of the characteristics outlined above is only partial in nature. Each type of capacitor is well suited to some fields and poorly suited to others. When actually designing circuits it is necessary to consider a number of factors on addition to the characteristics described above, such as cost and size, in order to select the best capacitor for the job if space is limited, all-purpose MLCCs are the best. MLCCs are also suitable for applications where the ability to deal with very high voltages is needed because of their high withstand voltage performance and ability to withstand reverse voltage. Typical polymer capacitors are a good choice when both, higher capacitance and low ESR are important. Especially the potential cost and space saving when comparing single polymer capacitors to an equivalent of multiple MLCCs can make a big difference in designing PCBs.

Taking these considerations into account we define following target specs for MLCC replacements with polymer capacitors:

- > Voltage Lines: 16 to 35V
- > Capacitance: 47 μ F to 560 μ F
(and since large capacitance is THE strength of polymer capacitors – the higher the better)
- > Preferably B & D case sizes

CIRCUIT EXAMPLE

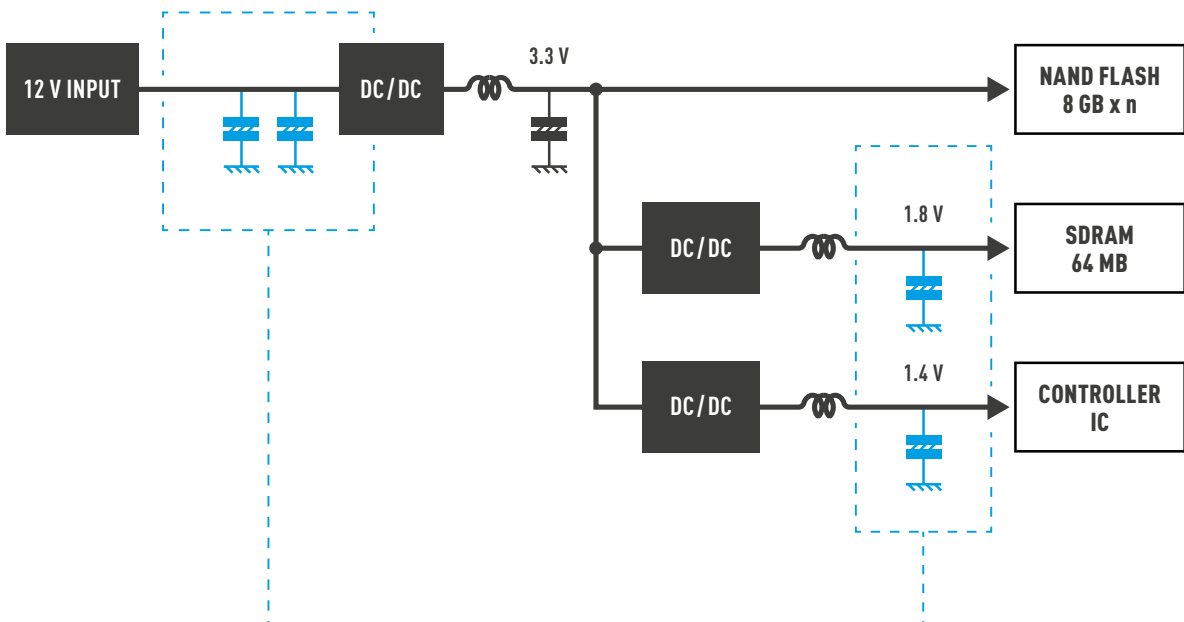

ORIGINAL: MLCC

MLCC (X5R) 16V / 47uF / 1210 x 18 pcs
 Initial capacitance: 846uF
 846 x 0.30 (DC Bias + Aging)
 Actual Capacitance: 254uF

57% DOWN SIZING

ORIGINAL: MLCC

MLCC (X5R) 4V / 100uF / 1206 x 15 pcs
 Initial capacitance: 1500uF
 846 x 0.30 (DC Bias + Aging)
 Actual Capacitance: 450uF

**59% DOWN SIZING
30% COST DOWN**

PROPOSAL: POS-CAP

Pos-Cap 16V / 150uF / 2917 x 2 pcs
 Initial capacitance: 300uF
 No influence DC Bias
 Actual Capacitance: 300uF

PROPOSAL: SP-CAP

SP-Cap 2V / 470uF / 2917 x 1 pcs
 Initial capacitance: 470uF
 No influence DC Bias
 Actual Capacitance: 470uF

Figure 7

