

1
RoHS Compliance

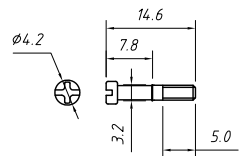
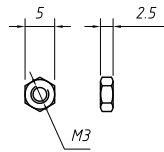
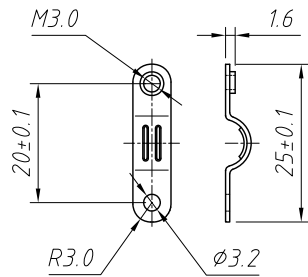

Short screw

Order Information:

L-KLS1-DB-09P-S-G

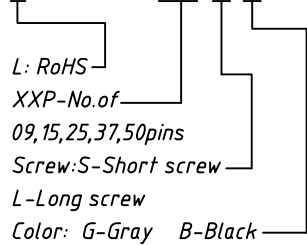

L: RoHS

XXP-No.of

09, 15, 25, 37, 50 pins

Screw: S-Short screw

L-Long screw

Color: G-Gray B-Black

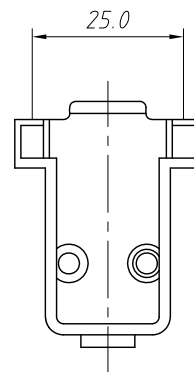
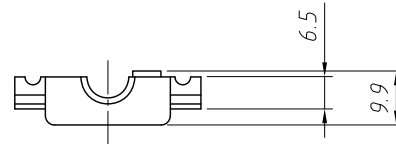
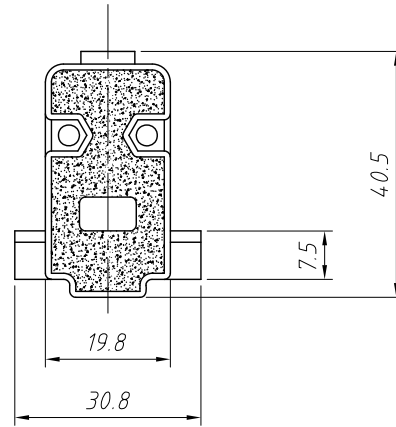

Cover Material: ABS Plastic
Screw Material: STEEL

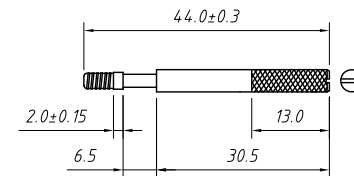
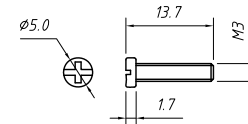
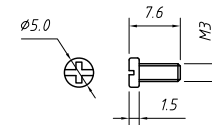
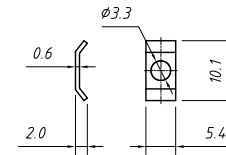

Long screw

ANGLE TOLERANCE		PROJECTION		Description:	
±3°				D-SUB HOOD PLASTIC MATERIAL (09-37Pin)	
GENERAL TOLERANCE		UNITS	mm	KLS P/N:	L-KLS1-DB-09P-S-G
x.x	±0.30	SHEET SIZE	A4		
x.xx	±0.20	Draw:	Daniel	2020-11-11	NingBo KLS ELECTRONIC CO.,LTD.
x.xxx	±0.10	Check:	Daniel	2020-11-11	

1
RoHS Compliance

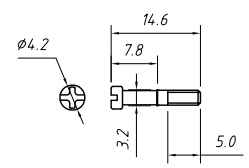
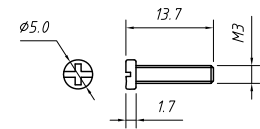
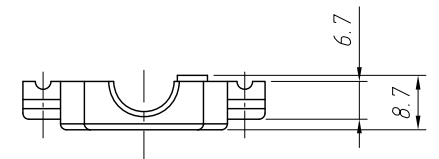
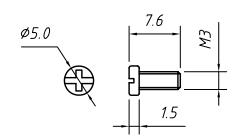
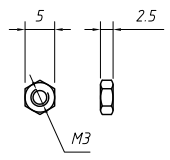
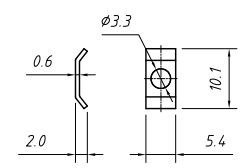
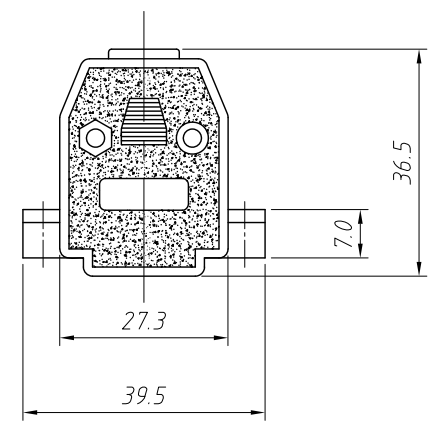
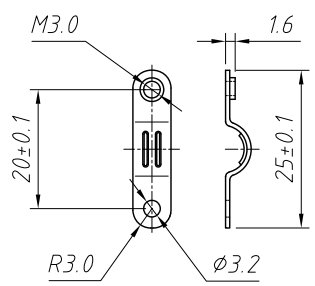

Short screw

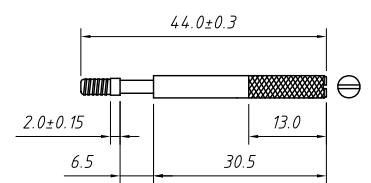
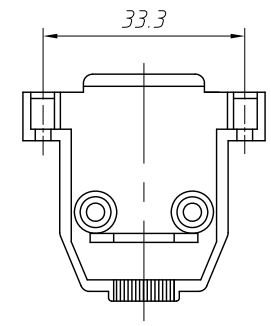

Long screw

Order Information:

L-KLS1-DB-15P-S-G

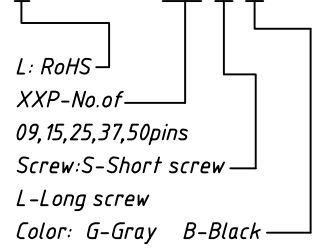

Cover Material: ABS Plastic
Screw Material: STEEL

ANGLE TOLERANCE	PROJECTION	Description:	
±3°		D-SUB HOOD PLASTIC MATERIAL (09-37Pin)	
GENERAL TOLERANCE	UNITS	mm	KLS P/N:
x.x ±0.30	SHEET SIZE	A4	L-KLS1-DB-15P-S-G
x.xx ±0.20	Draw:	Daniel	2020-11-11
x.xxx ±0.10	Check:	Daniel	2020-11-11



NingBo KLS ELECTRONIC CO.,LTD.

1
RoHS Compliance

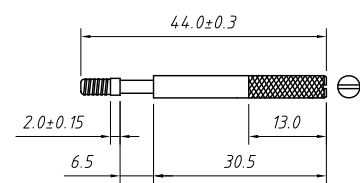
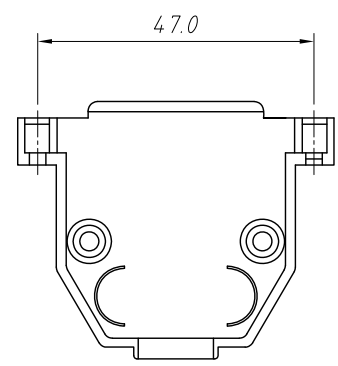
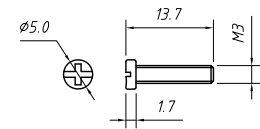
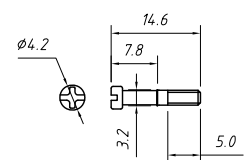
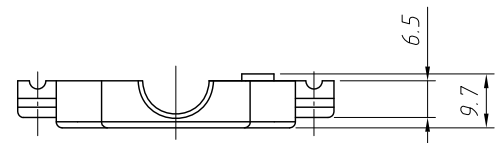
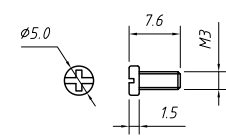
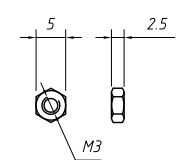
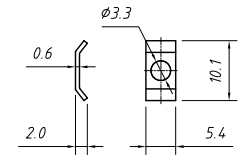
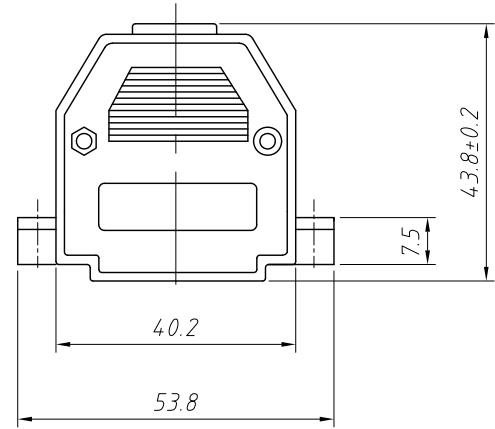
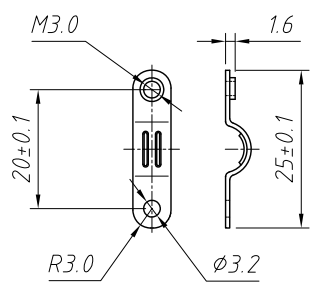

Order Information:
L-KLS1-DB-25P-S-G

L: RoHS
XXP-No.of
09,15,25,37,50pins
Screw:S-Short screw
L-Long screw
Color: G-Gray B-Black

Cover Material: ABS Plastic
Screw Material: STEEL

ANGLE TOLERANCE		PROJECTION		Description:	
±3°				D-SUB HOOD PLASTIC MATERIAL (09-37Pin)	
GENERAL TOLERANCE		UNITS	mm	KLS P/N:	L-KLS1-DB-25P-S-G
x.x	±0.30	SHEET SIZE	A4		
x.xx	±0.20	Draw:	Daniel	2020-11-11	NingBo KLS ELECTRONIC CO.,L TD.
x.xxx	±0.10	Check:	Daniel	2020-11-11	

1
RoHS Compliance

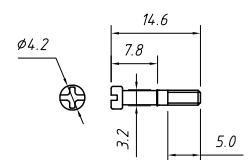
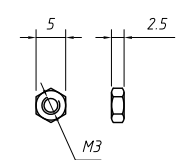
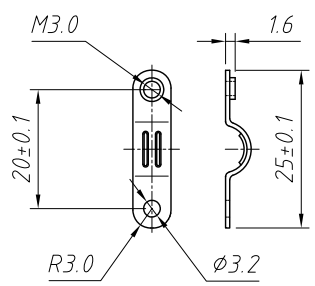

Short screw

Order Information:
L-KLS1-DB-37P-S-G

L: RoHS
XXP-No.of
09,15,25,37,50pins
Screw:S-Short screw
L-Long screw
Color: G-Gray B-Black

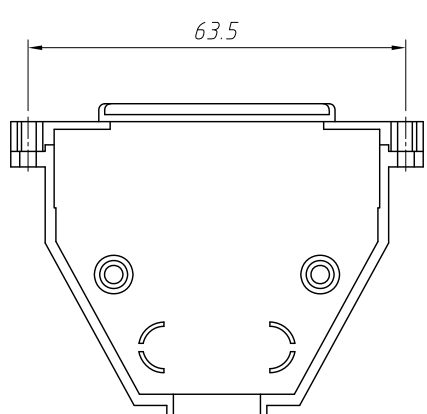
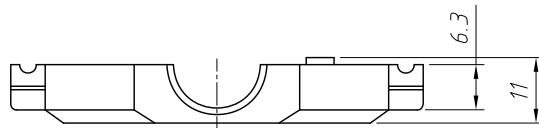
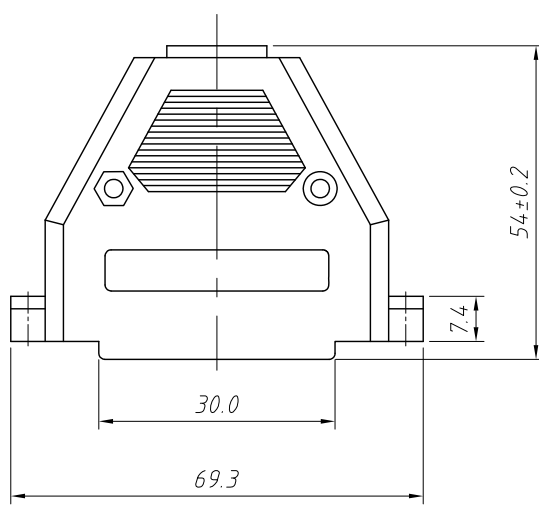

Cover Material: ABS Plastic
Screw Material: STEEL

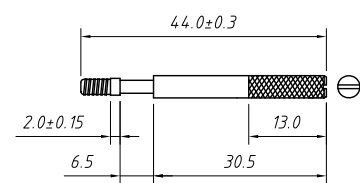
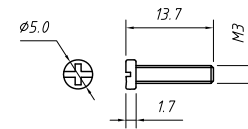
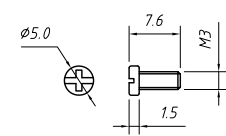
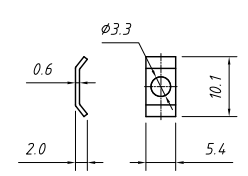

Long screw

ANGLE TOLERANCE		PROJECTION		Description:	
±3°				D-SUB HOOD PLASTIC MATERIAL (09-37Pin)	
GENERAL TOLERANCE		UNITS	mm	KLS P/N:	L-KLS1-DB-37P-S-G
x.x	±0.30	SHEET SIZE	A4		
x.xx	±0.20	Draw:	Daniel	2020-11-11	NingBo KLS ELECTRONIC CO.,L TD.
x.xxx	±0.10	Check:	Daniel	2020-11-11	